

LFO\_Peripheral  
File: LFO\_Peripheral.kicad\_sch

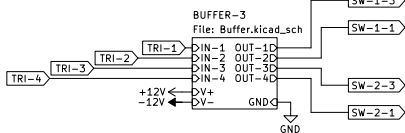

A\_Pins\_Peripheral

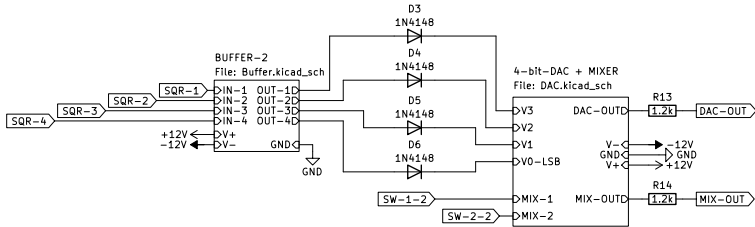
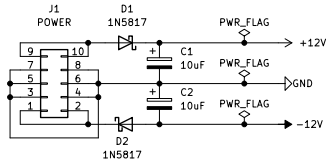
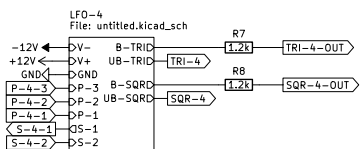
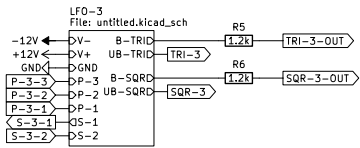
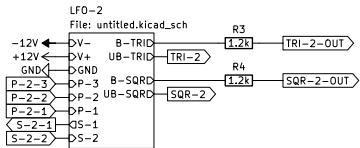
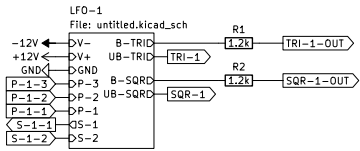
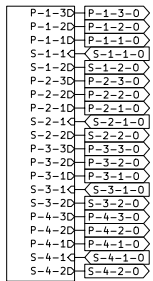
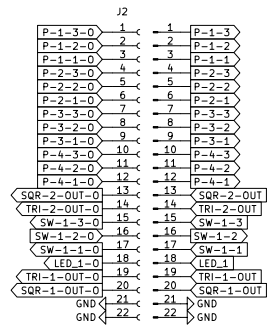

A\_Pins\_Circuit

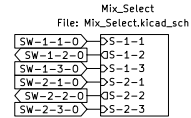
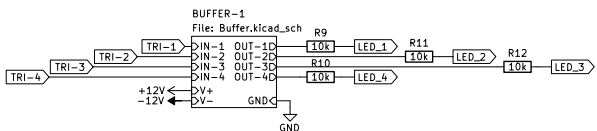

B\_Pins\_Peripheral

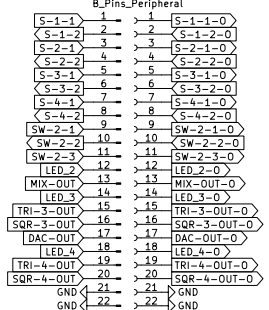

B\_Pins\_Circuit

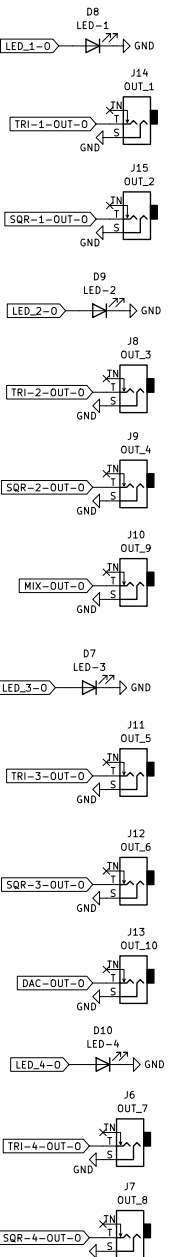
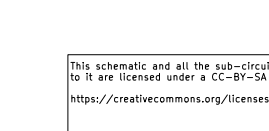

This schematic and all the sub-circuits joined to it are licensed under a CC-BY-SA 4.0 license.  
<https://creativecommons.org/licenses/by-sa/4.0/>

NOH-Modular

Drawn by Nicolas Viate.

Sheet: /		File: QLFO.kicad_sch	
<b>Title: QLFO</b>			
Size: A3	Date:	Rev: v1.0	
KiCad E.D.A. kicad (6.0.4-0)		Id: 1/11	

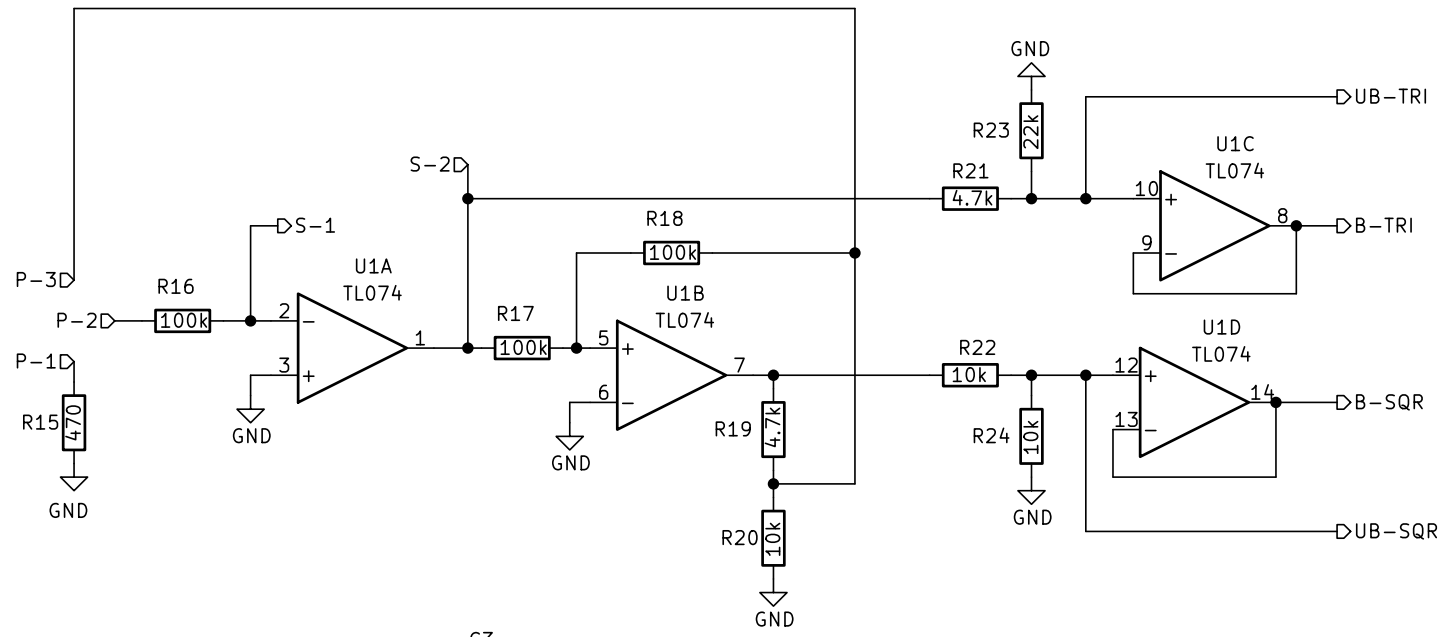

GNDD → GND

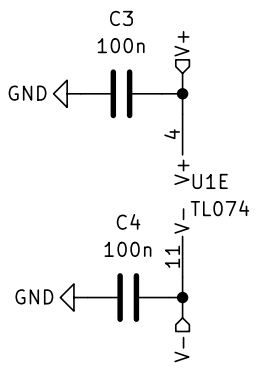

This schematic and all the sub-circuits joined to it are licensed under a CC-BY-SA 4.0 license.  
<https://creativecommons.org/licenses/by-sa/4.0/>

NOH-Modular

Drawn by Nicolas Viale.

Sheet: /LFO-1/  
 File: untitled.kicad\_sch

**Title: LFO**

Size: A5	Date:	Rev:
KiCad E.D.A. kicad (6.0.4-0)		Id: 2/11



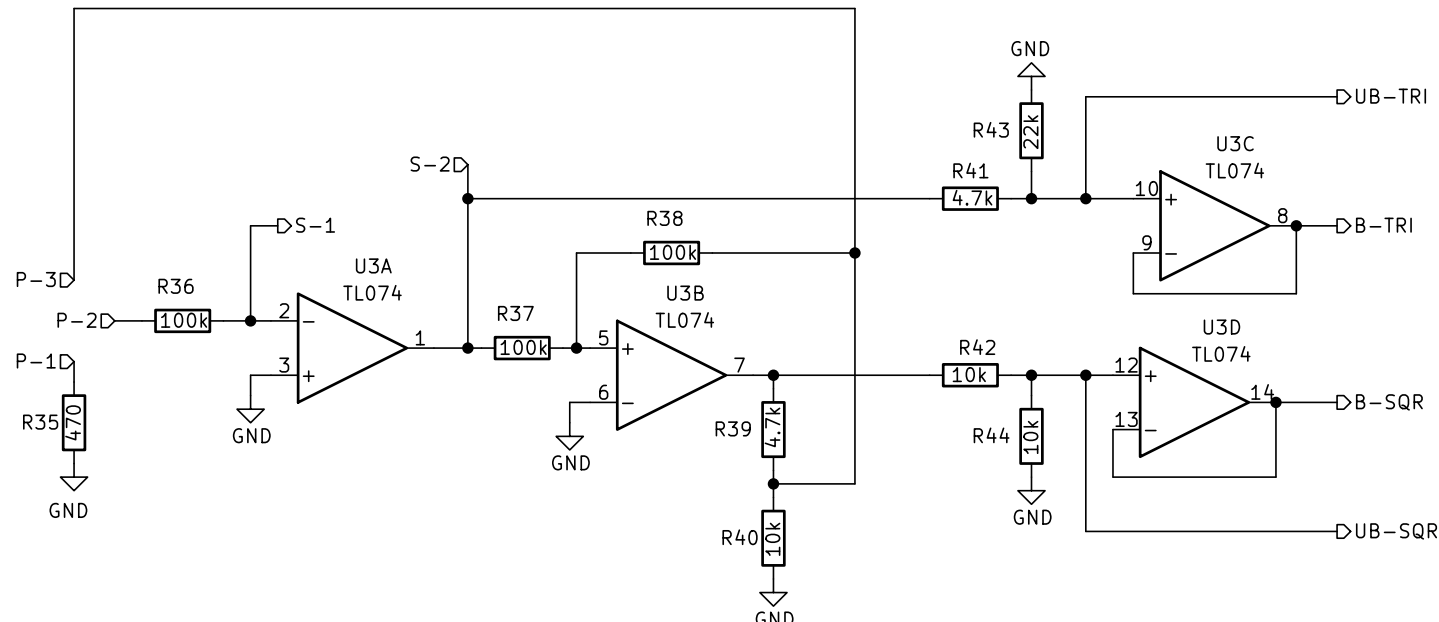

GND → GND

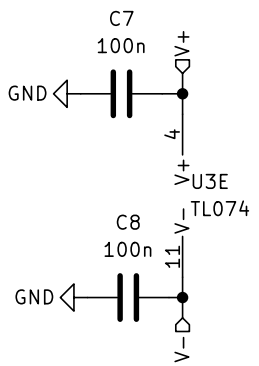

This schematic and all the sub-circuits joined to it are licensed under a CC-BY-SA 4.0 license.  
<https://creativecommons.org/licenses/by-sa/4.0/>

NOH-Modular

Drawn by Nicolas Viale.

Sheet: /LFO-3/  
 File: untitled.kicad\_sch

**Title: LFO**

Size: A5	Date:	Rev:
KiCad E.D.A. kicad (6.0.4-0)		Id: 4/11

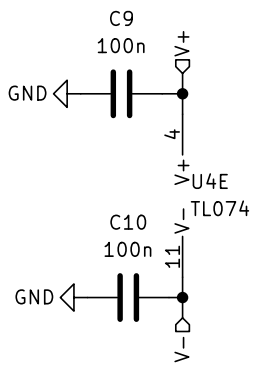
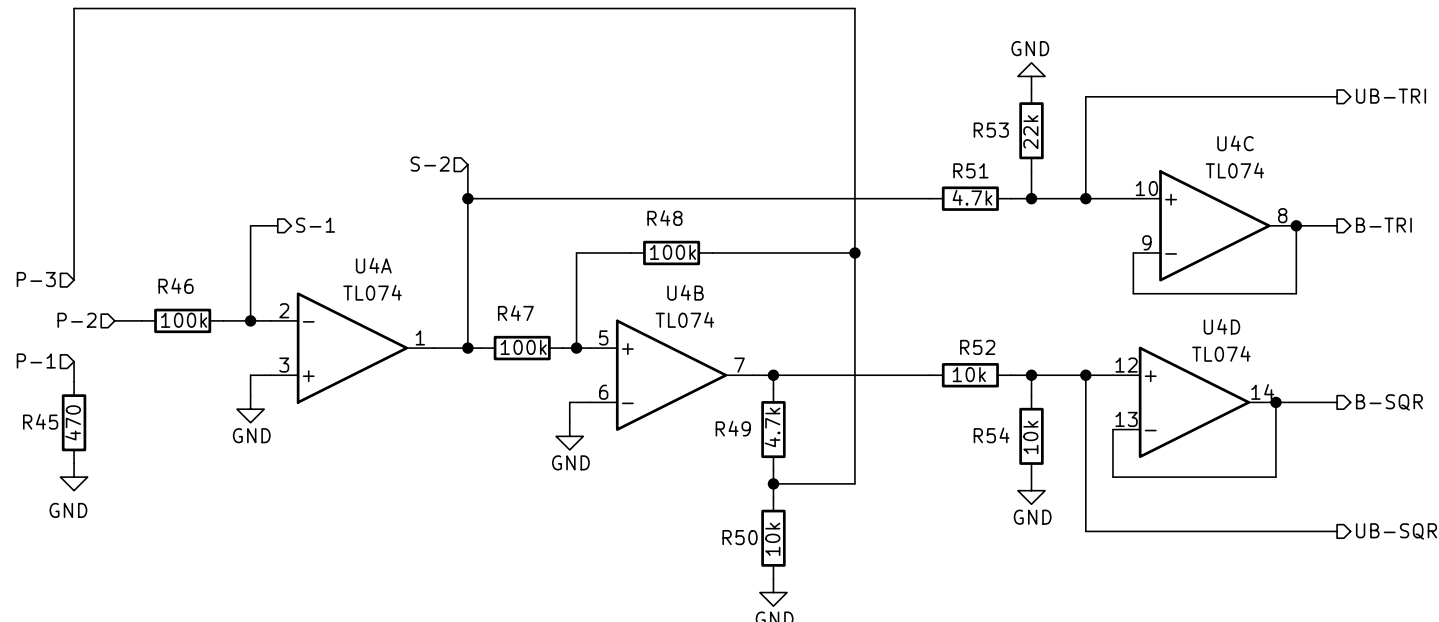

This schematic and all the sub-circuits joined to it are licensed under a CC-BY-SA 4.0 license.  
<https://creativecommons.org/licenses/by-sa/4.0/>

NOH-Modular

Drawn by Nicolas Viale.

Sheet: /LFO-4/  
 File: untitled.kicad\_sch

**Title: LFO**

Size: A5	Date:	Rev:
KiCad E.D.A. kicad (6.0.4-0)		Id: 5/11

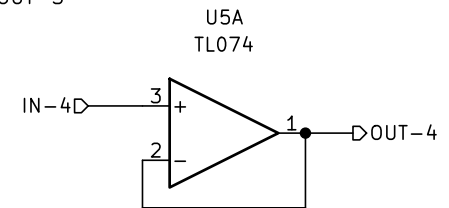
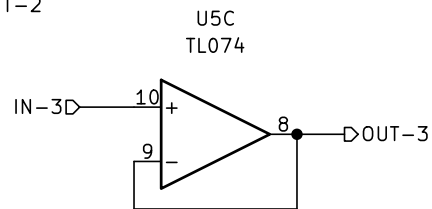
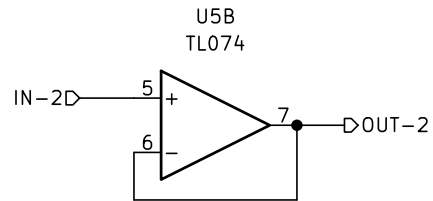
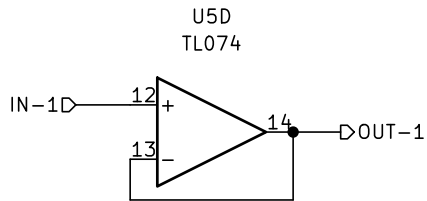

GND → GND

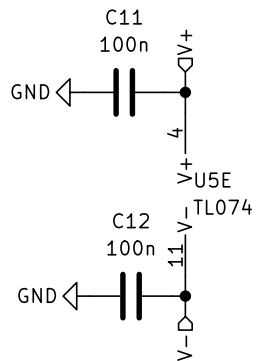

This schematic and all the sub-circuits joined to it are licensed under a CC-BY-SA 4.0 license.

<https://creativecommons.org/licenses/by-sa/4.0/>

NOH-Modular

Drawn by Nicolas Viale.

Sheet: /BUFFER-1/  
File: Buffer.kicad\_sch

**Title:**

Size: A5 Date:  
KiCad E.D.A. kicad (6.0.4-0)

**Rev:**  
Id: 6/11

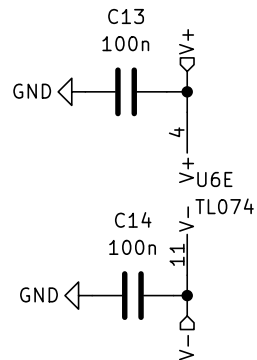
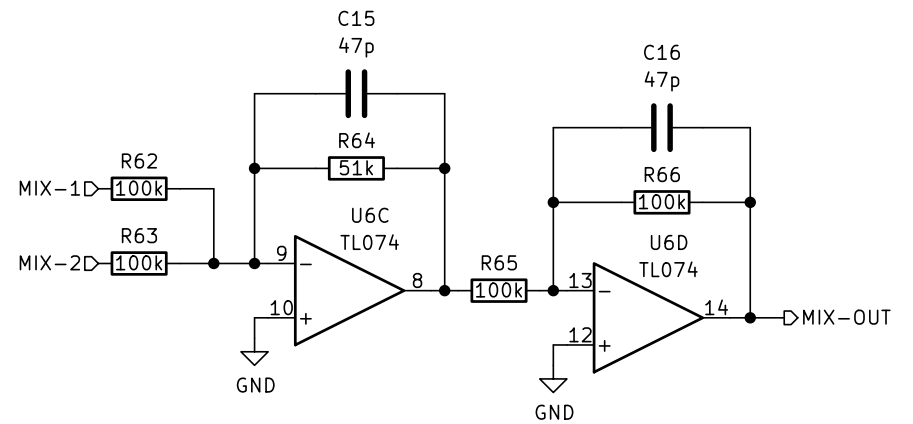
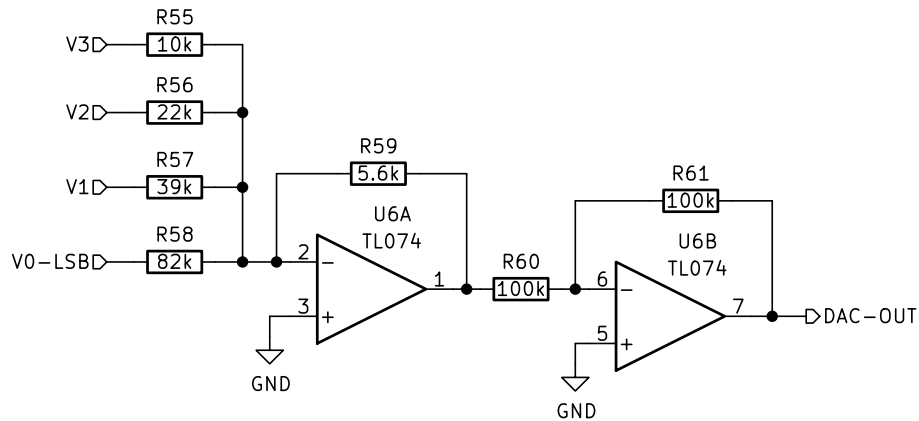

GND → GND

This schematic and all the sub-circuits joined to it are licensed under a CC-BY-SA 4.0 license.

<https://creativecommons.org/licenses/by-sa/4.0/>

NOH-Modular

Drawn by Nicolas Viale.

Sheet: /4-bit-DAC + MIXER/  
File: DAC.kicad\_sch

**Title:**

Size: A5 Date:  
KiCad E.D.A. kicad (6.0.4-0)

**Rev:**  
Id: 7/11

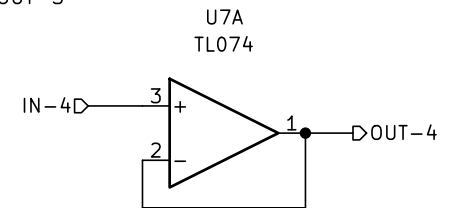
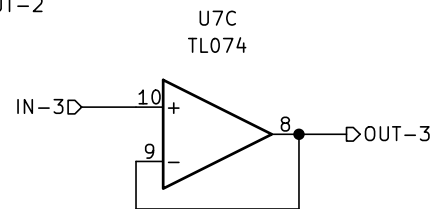
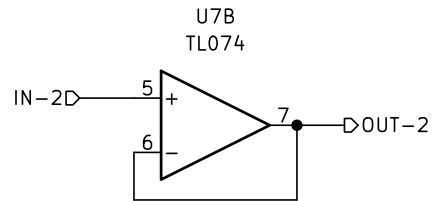
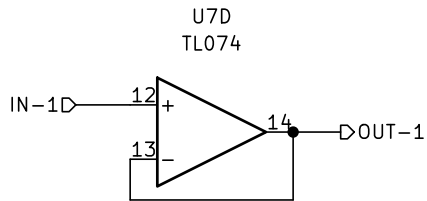

GND → GND

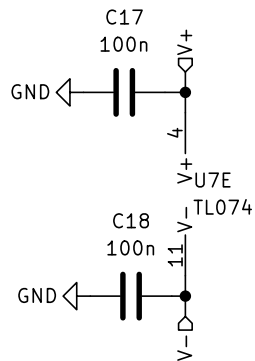

This schematic and all the sub-circuits joined to it are licensed under a CC-BY-SA 4.0 license.

<https://creativecommons.org/licenses/by-sa/4.0/>

NOH-Modular

Drawn by Nicolas Viale.

Sheet: /BUFFER-2/  
File: Buffer.kicad\_sch

**Title:**

Size: A5 Date:  
KiCad E.D.A. kicad (6.0.4-0)

**Rev:**  
Id: 8/11



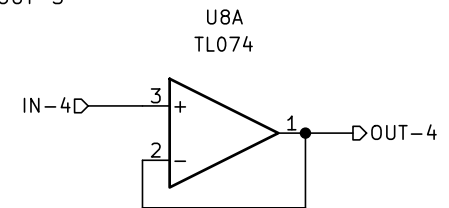
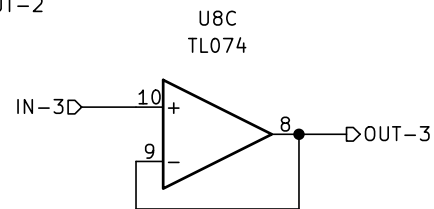
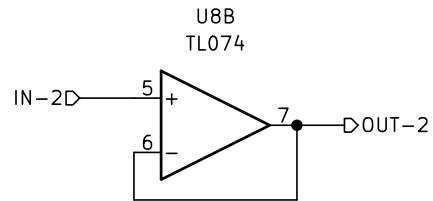
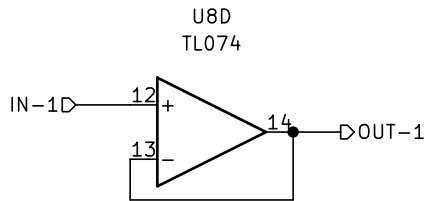

GND → GND

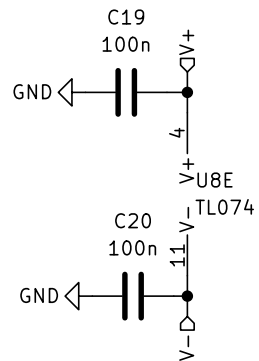

This schematic and all the sub-circuits joined to it are licensed under a CC-BY-SA 4.0 license.

<https://creativecommons.org/licenses/by-sa/4.0/>

NOH-Modular

Drawn by Nicolas Viale.

Sheet: /BUFFER-3/  
File: Buffer.kicad\_sch

**Title:**

Size: A5 Date:  
KiCad E.D.A. kicad (6.0.4-0)

**Rev:**  
Id: 9/11

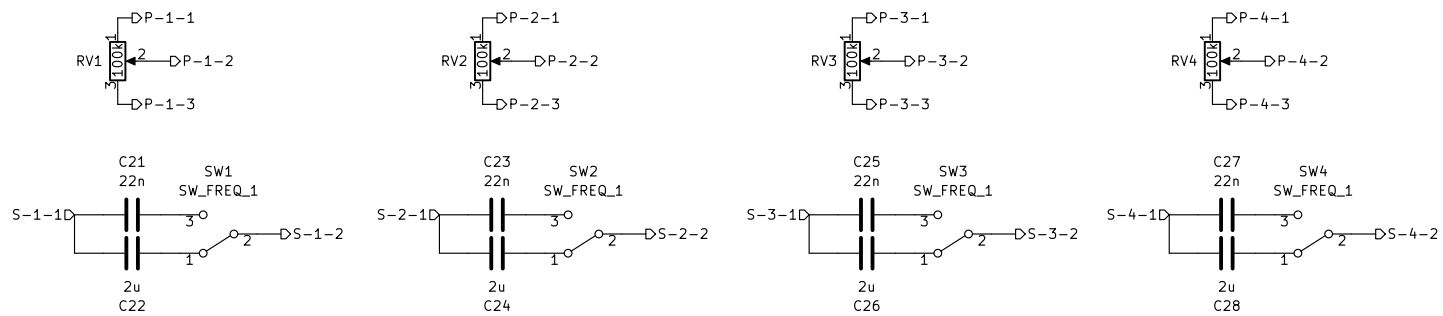

This schematic and all the sub-circuits joined to it are licensed under a CC-BY-SA 4.0 license.  
<https://creativecommons.org/licenses/by-sa/4.0/>

NOH-Modular

Drawn by Nicolas Viale.

Sheet: /LFO\_Peripheral/  
 File: LFO\_Peripheral.kicad\_sch

**Title:**

Size: A4  
 KiCad E.D.A. kicad (6.0.4-0)

Date:

**Rev:**  
 Id: 10/11

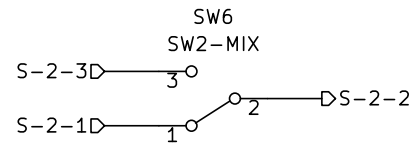
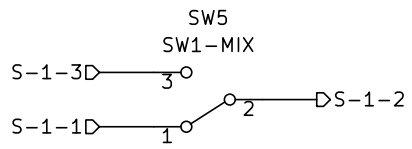

This schematic and all the sub-circuits joined to it are licensed under a CC-BY-SA 4.0 license.

<https://creativecommons.org/licenses/by-sa/4.0/>

NOH-Modular

Drawn by Nicolas Viale.

Sheet: /Mix\_Select/  
File: Mix\_Select.kicad\_sch

**Title:**

Size: A5

Date:

**Rev:**

KiCad E.D.A. kicad (6.0.4-0)

Id: 11/11